

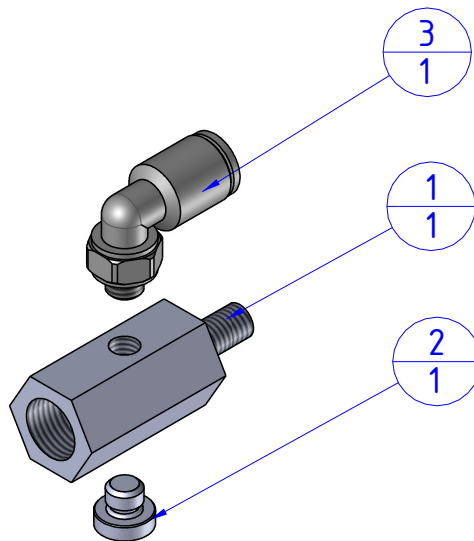

THE PROPERTY OF THE DRAWING IS ESTABLISHED BY LAW. IT IS FORBIDDEN TO PRODUCE OR SHOW IT TO THIRD PART. WITHOUT A WRITTEN AGREEMENT.

Item	Name	Q.ty
1	11-15-004	1
2	CA.08.14.013	1
3	CA.12.05.001	1

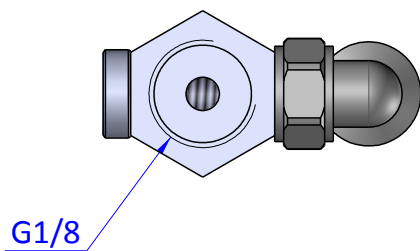
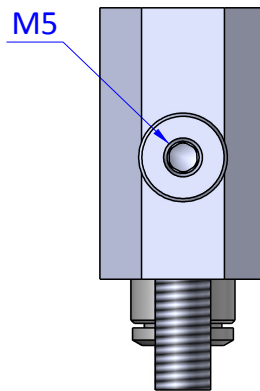
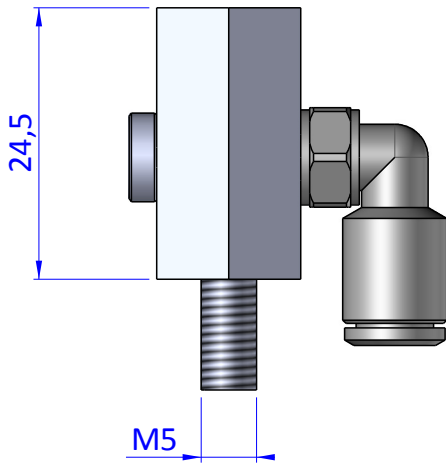
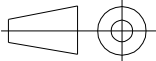

Format A4 UNI 936-76	 FPS FPSERVICES AUTOMATION			DESIGNED FROM FPS Automation	REVIEW A
	GENERAL TOLERANCE UNI - ISO 2768 CLASSE f	DESCRIPTION CA.11.15.004		DATE 20/05/2019	WEIGHT 0,004kg
				CODE CA.11.15.004	